

1		2		3		4		5		6	
Document No.	QR4-700-T-003	REV.	A/0	REV.	DESCRIPTION	REVISOR	DATE	APPROVED			
		0		LH.Mao		11.18.2016	David				

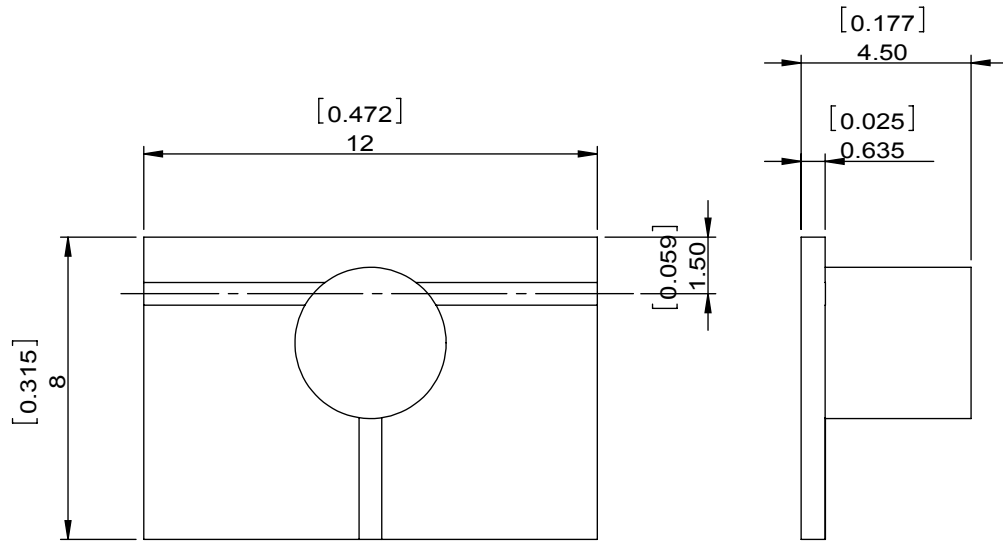

SPECIFICATIONS	
Part's Number	3CMM78-3
Frequency(GHz)	7.10-8.50
Direction	CW
Insertion Loss(dB)MAX	0.6
Insertion Loss Ripple	
Isolation(dB)MIN	20
Return Loss(dB)MIN	20.08
3rd IMD(dBc)MAX	
Power FWD/REV/PK(Watt)	5/5/-
Operating Temperature(°C)	-30~+70
Storage Temperature(°C)	
2nd/3rd Harmonic(dBc)	
Termination/Attenuator(Watt/dB)	5
Tab(W×LG×THK)(mm[Inch])	
Additional Notes	GWB

**DORADO** INTERNATIONAL **DORADO Millimeter Corp**

<b>MATERIAL:</b>	<b>DWG NO:</b> 3CMM78-3			
<b>SURFACE TREATMENT:</b>	DWG BY:	LH.Mao	11.18.2016	SCALE
	CHK'D BY:			
<b>DESCRIPTION:</b> MICROSTRIP CIRCULATOR	APP'V'D BY:			5:1
	Unit:	Tolerance:	The First:	A4
	mm[inch]	Liner: ±0.25 Anguar: ±0.5°		



This document is the property of DORADO Millimeter Corp. It cannot be copied, duplicated, used for manufacturing purposes or communicated to third party as a whole or partly, without the written consent of DORADO Millimeter Corp.