

1		2		3		4		5		6	
Document No. QR4-700-T-003								REV. DESCRIPTION REVISOR DATE APPROVED			
REV. A/0								0		LH.Mao 11.16.2016 David	

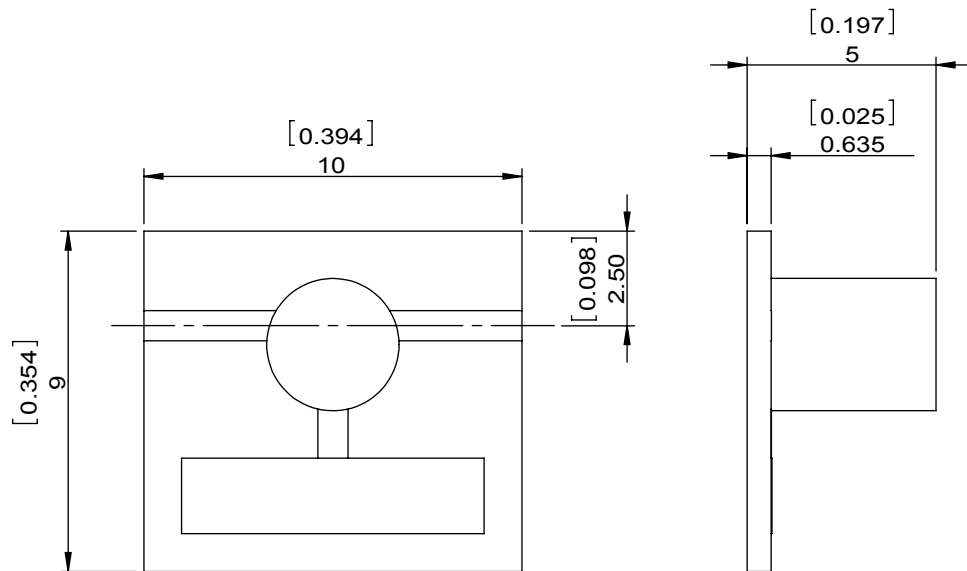

SPECIFICATIONS	
Part's Number	3IMM71-1
Frequency(GHz)	6.30-8.00
Direction	CW
Insertion Loss(dB)MAX	0.5
Insertion Loss Ripple	
Isolation(dB)MIN	20
Return Loss(dB)MIN	19.08
3rd IMD(dBc)MAX	
Power FWD/REV/PK(Watt)	5/0.25/-
Operating Temperature(°C)	-30~+70
Storage Temperature(°C)	
2nd/3rd Harmonic(dBc)	
Termination/Attenuator(Watt/dB)	0.25
Tab(W×LG×THK)(mm[Inch])	
Additional Notes	GWB

DORADO INTERNATIONAL **DORADO Millimeter Corp**

MATERIAL:	DWG NO: 3IMM71-1			
SURFACE TREATMENT:	DWG BY: LH.Mao	11.16.2016	SCALE	5:1
DESCRIPTION: MICROSTRIP ISOLATOR	CHK'D BY:			
	APPV'D BY:			A4
	Unit: mm[inch]	Tolerance: Liner: ±0.25 Anguar: ±0.5°	The First:	



This document is the property of DORADO Millimeter Corp. It cannot be copied, duplicated, used for manufacturing purposes or communicated to third party as a whole or partly, without the written consent of DORADO Millimeter Corp.