

1		2		3		4		5		6	
Document No.	QR4-700-T-003	REV.	A/0	REV.	DESCRIPTION	REVISOR	DATE	APPROVED			
		0				LH.Mao	11.01.2016	David			

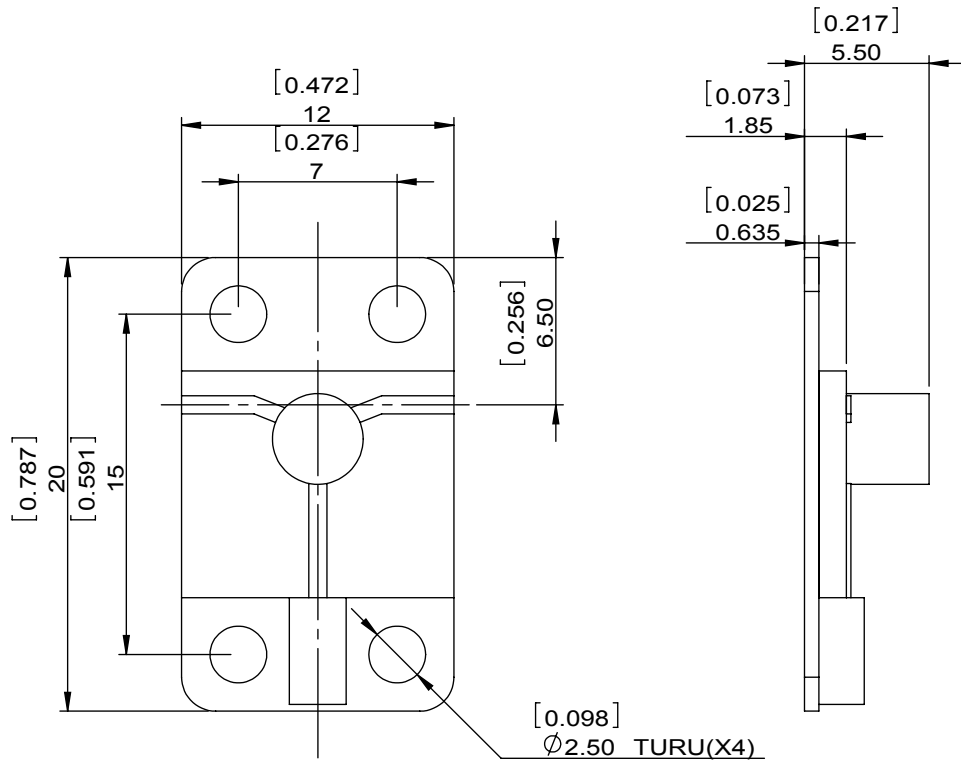

SPECIFICATIONS	
Part's Number	3IMS78-2
Frequency(GHz)	7.10-8.50
Direction	CW
Insertion Loss(dB)MAX	0.5
Insertion Loss Ripple	
Isolation(dB)MIN	20
Return Loss(dB)MIN	19.08
3rd IMD(dBc)MAX	
Power FWD/REV/PK(Watt)	10/2/-
Operating Temperature(°C)	-30~+70
Storage Temperature(°C)	
2nd/3rd Harmonic(dBc)	
Termination/Attenuator(Watt/dB)	2
Tab(W×LG×THK)(mm[Inch])	
Additional Notes	GWB

DORADO Millimeter Corp				
MATERIAL:		DWG NO: 3IMS78-2		
SURFACE TREATMENT:		DWG BY:	LH.Mao	11.01.2016
DESCRIPTION: MICROSTRIP ISOLATOR		CHK'D BY:		SCALE
		APPV'D BY:		3:1
		Unit: mm[inch]	Tolerance: Liner: ±0.25 Anguar: ±0.5°	The First:
				A4



This document is the property of DORADO Millimeter Corp. It cannot be copied, duplicated, used for manufacturing purposes or communicated to third party as a whole or partly, without the written consent of DORADO Millimeter Corp.