

1		2		3		4		5		6	
Document No.	QR4-700-T-003	REV.	A/0	REV.	DESCRIPTION	REVISOR	DATE	APPROVED			
		0		LH.Mao		11.16.2016		David			

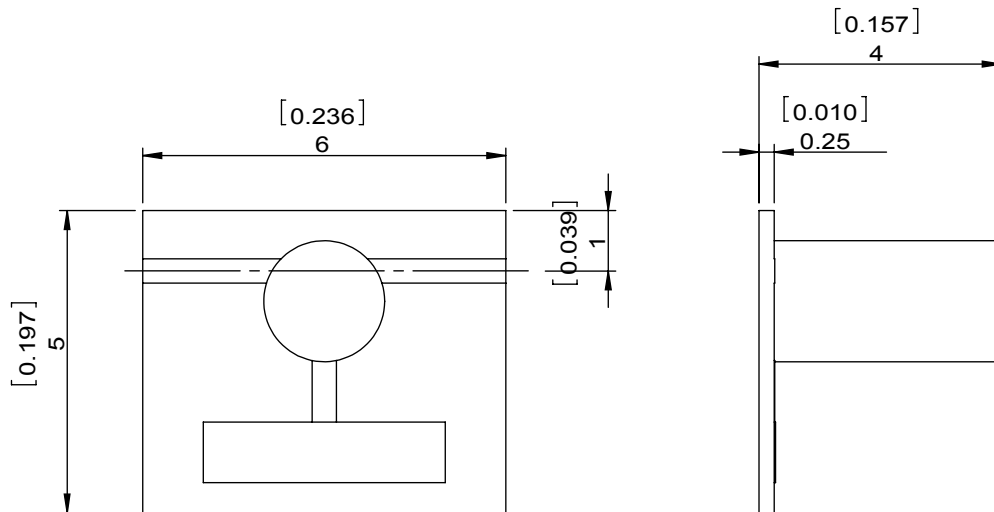

SPECIFICATIONS	
Part's Number	4IMM29-1
Frequency(GHz)	27.35-31.76
Direction	CW
Insertion Loss(dB)MAX	1
Insertion Loss Ripple	
Isolation(dB)MIN	18
Return Loss(dB)MIN	16.54
3rd IMD(dBc)MAX	
Power FWD/REV/PK(Watt)	2/1/-
Operating Temperature(°C)	-30~+70
Storage Temperature(°C)	
2nd/3rd Harmonic(dBc)	
Termination/Attenuator(Watt/dB)	1
Tab(W×LG×THK)(mm[Inch])	
Additional Notes	GWB

DORADO Millimeter Corp				
MATERIAL:		DWG NO:		
		4IMM29-1		
SURFACE TREATMENT:		DWG BY:	LH.Mao	11.16.2016
		CHK'D BY:		SCALE
DESCRIPTION:		APPV'D BY:		8:1
MICROSTRIP ISOLATOR		Unit:	Tolerance:	The First:
		mm[inch]	Liner: ±0.25	
			Anguar: ±0.5°	A4



This document is the property of DORADO Millimeter Corp. It cannot be copied, duplicated, used for manufacturing purposes or communicated to third party as a whole or partly, without the written consent of DORADO Millimeter Corp.