

1		2		3		4		5		6			
Document No.	QR4-700-T-003	REV.	A/0	REV.	DESCRIPTION	REVISOR	DATE	APPROVED	0		LH.Mao	11.08.2016	David

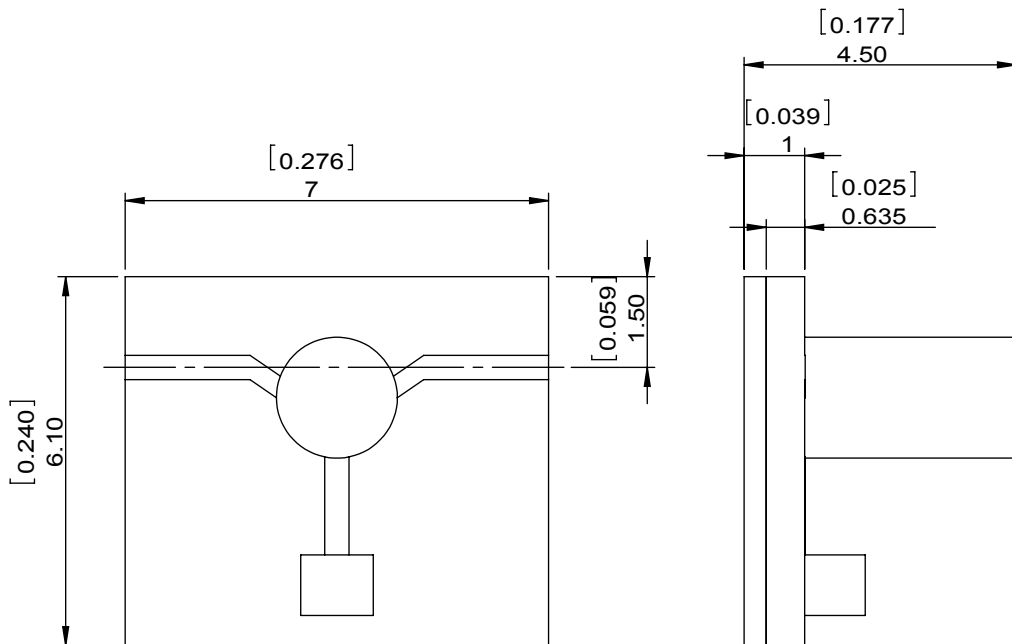

SPECIFICATIONS	
Part's Number	4IMS10-4
Frequency(GHz)	10.00-11.00
Direction	CW
Insertion Loss(dB)MAX	0.5
Insertion Loss Ripple	
Isolation(dB)MIN	20
Return Loss(dB)MIN	19.08
3rd IMD(dBc)MAX	
Power FWD/REV/PK(Watt)	5/0.25/-
Operating Temperature(°C)	-30~+70
Storage Temperature(°C)	
2nd/3rd Harmonic(dBc)	
Termination/Attenuator(Watt/dB)	0.25
Tab(W×LG×THK)(mm[Inch])	
Additional Notes	GWB

<b>DORADO Millimeter Corp</b>				
<b>MATERIAL:</b>		<b>DWG NO:</b> 4IMS10-4		
<b>SURFACE TREATMENT:</b>		DWG BY:	LH.Mao	11.08.2016
<b>DESCRIPTION:</b> MICROSTRIP ISOLATOR		CHK'D BY:		SCALE
		APPV'D BY:		8:1
		Unit: mm[inch]	Tolerance: Liner: ±0.25 Anguar: ±0.5°	The First: 
				A4



This document is the property of DORADO Millimeter Corp. It cannot be copied, duplicated, used for manufacturing purposes or communicated to third party as a whole or partly, without the written consent of DORADO Millimeter Corp.